

»G« Series

GFRL 11–GFRL 55 A

Symbol

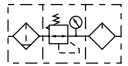

Product features

Three-piece service units consisting of a reversible diaphragm pressure regulator, independent of inlet pressure, with self-relieving design, centrifugal separator and proportional lubricator.

Specifications / Technical data

Art. No.	Size 300			Size 400		Size 600		
	GFRL 11, GFRL 11 A	GFRL 12, GFRL 12 A	GFRL 13, GFRL 13 A	GFRL 32, GFRL 32 A	GFRL 33, GFRL 33 A	GFRL 34, GFRL 34 A	GFRL 55, GFRL 55 A	
Fluid	Air							
Port size	1/4"	3/8"	1/2"	3/8"	1/2"	3/4"	1"	
Filtering grade	5 µm (40 µm on request)							
Pressure range	1.5 to 9 bar (0.15 to 0.9 MPa, 20 to 130 psi)							
Proof pressure	15 bar (1.5 MPa, 215 psi)							
Temperature range	-20 to 70 °C							
Capacity of drain bowl	40 cm ³			80 cm ³		230 cm ³		
Capacity of oil bowl	75 cm ³			160 cm ³		380 cm ³		
Recommended lubricant	Mineral oil, viscosity 32 cSt, acc. to DIN 51524 - ISO VG 32							
Weight	1300 g			2360 g		5550 g		
Constitute	Filter	GF 11, GF 11 A	GF 12, GF 12 A	GF 13, GF 13 A	GF 32, GF 32 A	GF 33, GF 33 A	GF 34, GF 34 A	GF 55, GF 55 A
	Regulator	GR 11	GR 12	GR 13	GR 32	GR 33	GR 34	GR 55
	Lubricator	GL 11	GL 12	GL 13	GL 32	GL 33	GL 34	GL 55

Ordering information

Art. No.	Type
GFRL 11–GFRL 13, GFRL 32, GFRL 33	Service units, 3-piece with polycarbonate bowl, bowl guard and joiner for wall mounting, semi-automatic drain valve
GFRL 34, GFRL 55	Service units, 3-piece with metal bowl, sight glass and joiner for wall mounting, semi-automatic drain valve
GFRL 11 A–GFRL 13 A, GFRL 32 A, GFRL 33 A	Service units, 3-piece with polycarbonate bowl, bowl guard and joiner for wall mounting, fully-automatic drain valve
GFRL 34 A, GFRL 55 A	Service units, 3-piece with metal bowl, sight glass and joiner for wall mounting, fully-automatic drain valve

Pressure chart

GFRL 11–GFRL 13, GFRL 11 A–GFRL 13 A

GFRL 32, GFRL 33, GFRL 32 A, GFRL 33 A

GFRL 34, GFRL 55, GFRL 34 A, GFRL 55 A

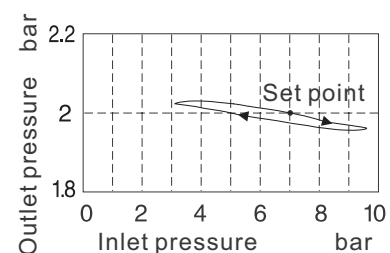
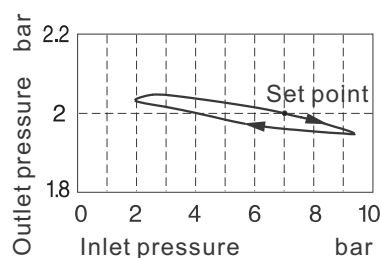
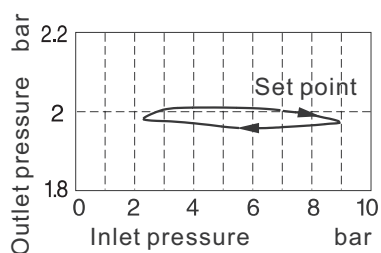

»G« Series

GFRL 11–GFRL 55 A

Flow chart

GFRL 12*, GFRL 13, GFRL 12 A, GFRL 13 A GFRL 32, GFRL 33, GFRL 32 A, GFRL 33 A GFRL 34, GFRL 55, GFRL 34 A, GFRL 55 A

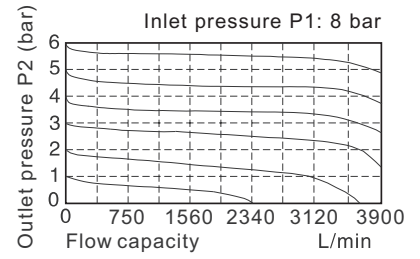
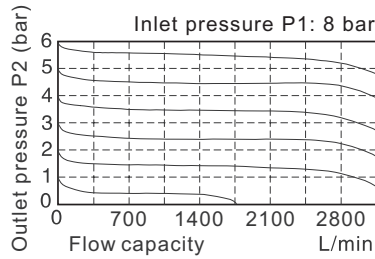
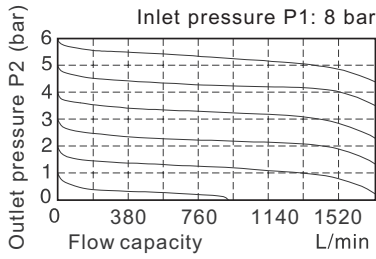

*Flow rates GFRL 11, GFRL 11 A approx. 22% less

Body dimensions

GFRL 11–GFRL 13, GFRL 32, GFRL 33, GFRL 11 A–GFRL 13 A, GFRL 32 A, GFRL 33 A

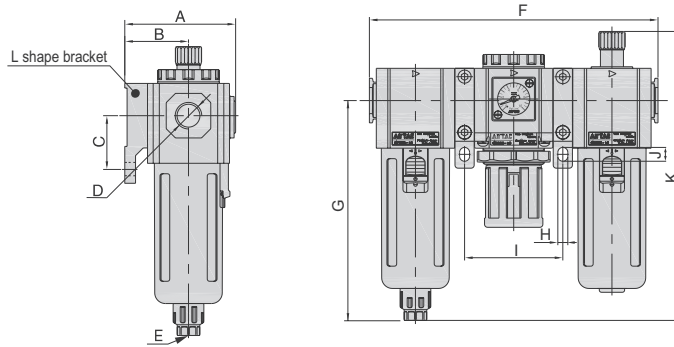

Art. No.	A	B	C	D	E	F	G	H	I	J	K
GFRL 11, GFRL 11 A	72	41.5	35	1/4"	G1/8	188	143	6.5	64	9	188
GFRL 12, GFRL 12 A	72	41.5	35	3/8"	G1/8	188	143	6.5	64	9	188
GFRL 13, GFRL 13 A	72	41.5	35	1/2"	G1/8	188	143	6.5	64	9	188
GFRL 32, GFRL 32 A	89	50	40	3/8"	G1/4	248	166.5	8.5	84	12	216
GFRL 33, GFRL 33 A	89	50	40	1/2"	G1/4	248	166.5	8.5	84	12	216

(Values in mm, exception D = inch)

GFRL 34, GFRL 55, GFRL 34 A, GFRL 55 A

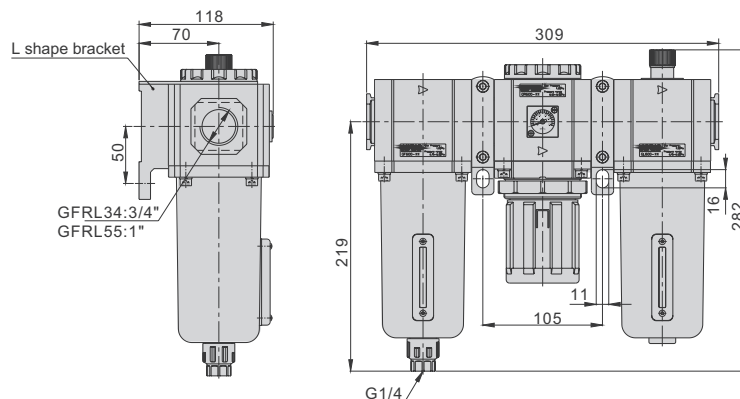

»G« Series

GFRL 11–GFRL 55 A





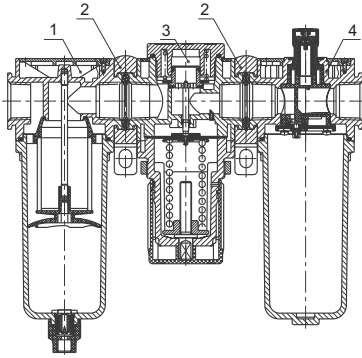





Components and materials

GFRL 11–GFRL 55 A



No.	Item	Material (body)
1	G series filter	Aluminium alloy
2	Bracket	Aluminium alloy
3	G series regulator	Aluminium alloy
4	G series lubricator	Aluminium alloy

Accessories





	For GFRL 11–GFRL 13, GFRL 11 A–GFRL 13 A	For GFRL 32–GFRL 33, GFRL 32 A–GFRL 33 A	For GFRL 34–GFRL 55, GFRL 34 A–GFRL 55 A	Type
	Art. No.	Art. No.	Art. No.	
	GR 11 100	GR 32 100	GR 34 100	Set of wearing parts for pressure regulators/ filter regulators
	GR 11 110	GR 32 110	GR 34 110	Replacement diaphragm
	GR 05 120	GR 32 120	GR 32 120	Adapter plate for mounting standard pressure gauges (round)
	110.46-KD	206-KD	206-KD	Standard pressure gauges
	GF 11 300	GF 32 300	GF 34 300	Polycarbonate bowl with semi-automatic drain valve for filters/filter regulators
	GF 11 600	GF 32 600	GF 34 600	Polycarbonate bowl with automatic drain valve for filters/filter regulators
	GF 11 500	GF 32 500	–	Protective cage
	GF 11 400	GF 32 400	GF 34 400	Filter element 5 µm
	GL 11 200	GL 32 200	–	Polycarbonate bowl for oil-mist lubricators
	GL 11 300	GL 32 300	–	Polycarbonate bowl with bowl guard for oil- mist lubricators

(Pictures are similar to product.)

»G« Series

GFRL 11–GFRL 55 A

Accessories

	For GFRL 11–GFRL 13, GFRL 11 A–GFRL 13 A	For GFRL 32–GFRL 33, GFRL 32 A–GFRL 33 A	For GFRL 34–GFRL 55, GFRL 34 A–GFRL 55 A	Type
	Art. No.	Art. No.	Art. No.	
	–	–	GL 34 M	Metal bowl with sight glass for oil-mist lubricators
	UB 300	UB 400	UB 600	Joiner without wall mounting
	LB 300	LB 400	LB 600	Joiner with wall mounting, 1 drilled hole
	TB 300	TB 400	TB 600	Joiner with wall mounting, 2 drilled holes

(Pictures are similar to product.)